



SBC-65 65" BOTTLE COOLER

UNITS MANUFACTURED PRIOR 10-1-18

INCLUDE 1 YEAR PARTS + LABOR / 5 YEAR COMPRESSOR WARRANTY

UNITS MANUFACTURED AFTER 10-1-18

INCLUDE 2 YEAR PARTS + LABOR / 5 YEAR COMPRESSOR WARRANTY

Dimensions

Exterior Dimensions (WxDxH)	64.5" x 26.5" x 34"
Interior Dimensions (WxDxH)	60.5" x 20" x 25.5"
Net Volume (cu. ft.)	18 cu. ft.
Gross Weight	254 lbs
Packaging Dimensions (WxDxH)	69.5" x 32.5" x 42.5"
Electrical Cord Length	98.5"
Cases of Beer	24

Cooling

Temperature Range	32° - 40° F
Refrigerant	R134a
Maximum Ambient Temperature Rating	90° F
Defrosting	Automatic
Cooling System	Ventilated
Temperature Display	No
Temperature Controller	Mechanical
H/P	1/3

Construction

Exterior Material	Painted Steel
Insulation Material	Foamed in place polyurethane
Shelf Material	Plastic coated steel
Shelf Load Capacity	132 lbs

Electrical

Voltage	115
Amps	8.5
Hz	60

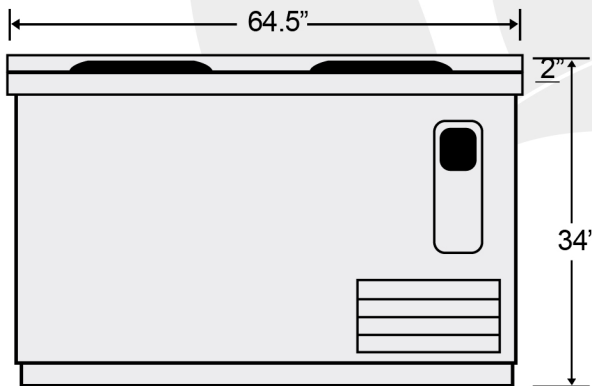

Front View

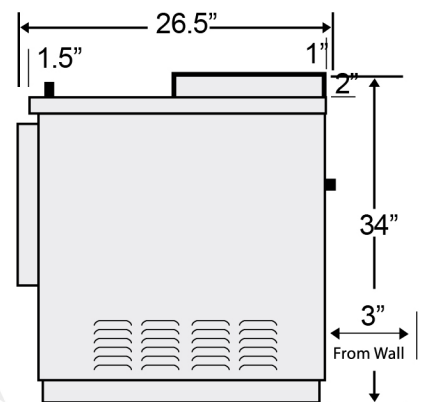

Side View



Top View

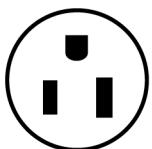

NEMA 5-15P

